



ARMOR SERIES

Lighting for Correctional Facilities



CONTENT

OUR TECHNOLOGY	4
LUMINAIRES FOR CORRECTIONAL FACILITIES	6
DISCOVER OUR CORRECTIONAL FIXTURES	9
CORNER AND WALL-MOUNT LUMINAIRES	10
NEW PRODUCT - PUJAC	12
PUOA, MURA	14
PUJA, PUMA	15
RECESSED LUMINAIRES	16
PRPA, PRTA	17
MARGAL	18
MARGA1, MARGA2	19
MDA4, MDA6	21
SURFACE MOUNT LUMINAIRES	22
PUFA	24
PUWA, PUSA	25
PUCSA, PUCSW	27
AC700	29
CSLA	31



PACO'S TECHNOLOGY

PACO manufactures luminaires to adhere to the most rigorous standards, ensuring their resilience even within the challenging prison cell environment.



CORRECTIONAL / INSTITUTIONAL LIGHTING SOLUTIONS

PACO Lighting offers an extensive line of luminaires meticulously designed to endure even the most extreme conditions, all while ensuring optimal and secure levels of illumination. Our luminaires are available in an array of gauges, lensing alternatives, and styles, catering to environments spanning from minimum security installations to super-maximum facilities.

CIRCADIAN LIGHTING

THE BENEFITS OF TUNABLE LIGHTING IN PRISONS

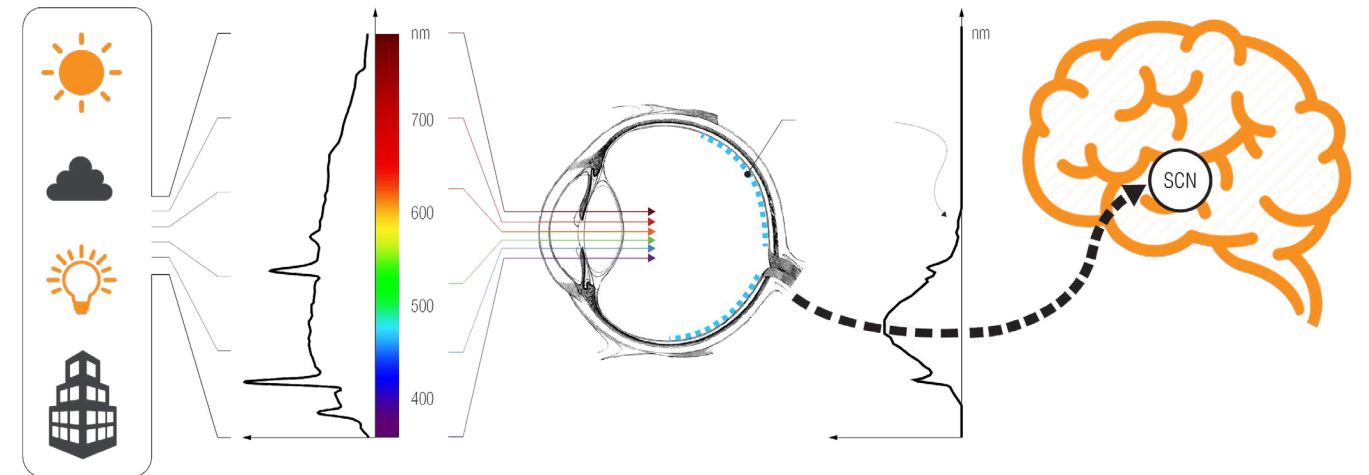

ENHANCED MENTAL AND EMOTIONAL WELL-BEING

One of the primary benefits of circadian lighting in prisons is its ability to enhance inmates' mental and emotional well-being. The natural light spectrum, with its varying color temperatures and intensities throughout the day, helps regulate inmates' circadian rhythms.

BENEFITS BEYOND STANDARD ILLUMINATION

Stress Reduction: By simulating the soothing transitions from cool morning to warm evening light, circadian lighting can help mitigate the anxiety and tension often experienced in correctional settings.

Improved Sleep Quality: Well-rested inmates are more likely to engage in rehabilitation programs and follow institutional rules.

Calming Effect: The gradual shifts in lighting color and intensity throughout the day can have a calming effect on inmates.

Enhanced Focus and Productivity: Exposure to natural light patterns has been shown to improve focus and cognitive function. More alert and focused inmates are less likely to engage in disruptive activities.

LUMINAIRES FOR CORRECTIONAL FACILITIES



Discover the **ARMOR SERIES**, a range of luminaires that offers a myriad of housing styles and lens materials, setting a new industry benchmark for:

1. Safety & Security: Our luminaires are designed to enhance safety and security in any environment, providing reliable illumination when it matters most.

2. Illumination: Experience exceptional lighting solutions that illuminate spaces and elevate their aesthetics, creating inviting and comfortable environments.

3. Energy Efficiency: We prioritize sustainability by incorporating cutting-edge energy-efficient technologies, ensuring you reduce your environmental footprint while saving on operational costs.

This versatile family of luminaires empowers specifiers to tailor fixtures to various security levels and preferred choices for:

- Prison cell lighting
- Corridors lighting
- Cafeteria lighting
- Washroom lighting
- Catwalks lighting
- Recreation area lighting
- Sally Ports
- Exterior lighting

CHOOSE TO FIT YOUR NEEDS!

All of our correctional luminaires feature standard and tamper-proof/anti-vandal security features. The primary enhancements that render our fixtures suitable for correctional and psychiatric facilities are heavier gauge steel and thicker polycarbonate security lenses.

The higher the security level needed the thicker the steel gauge and security lens will be.

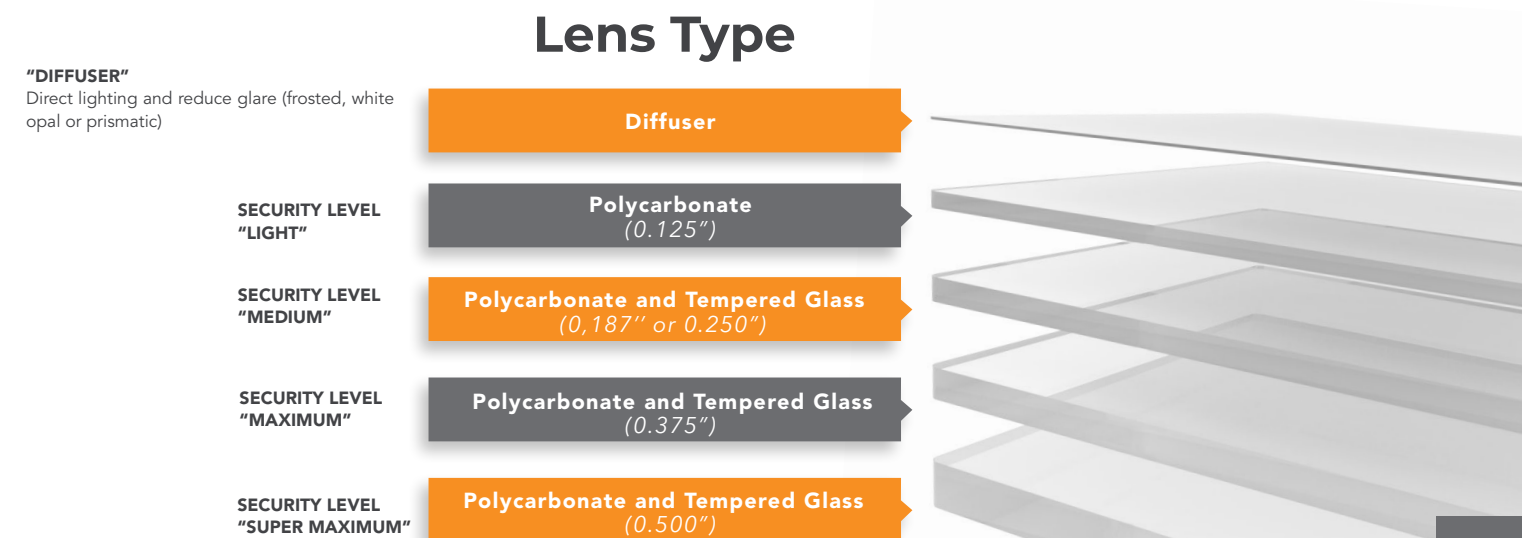
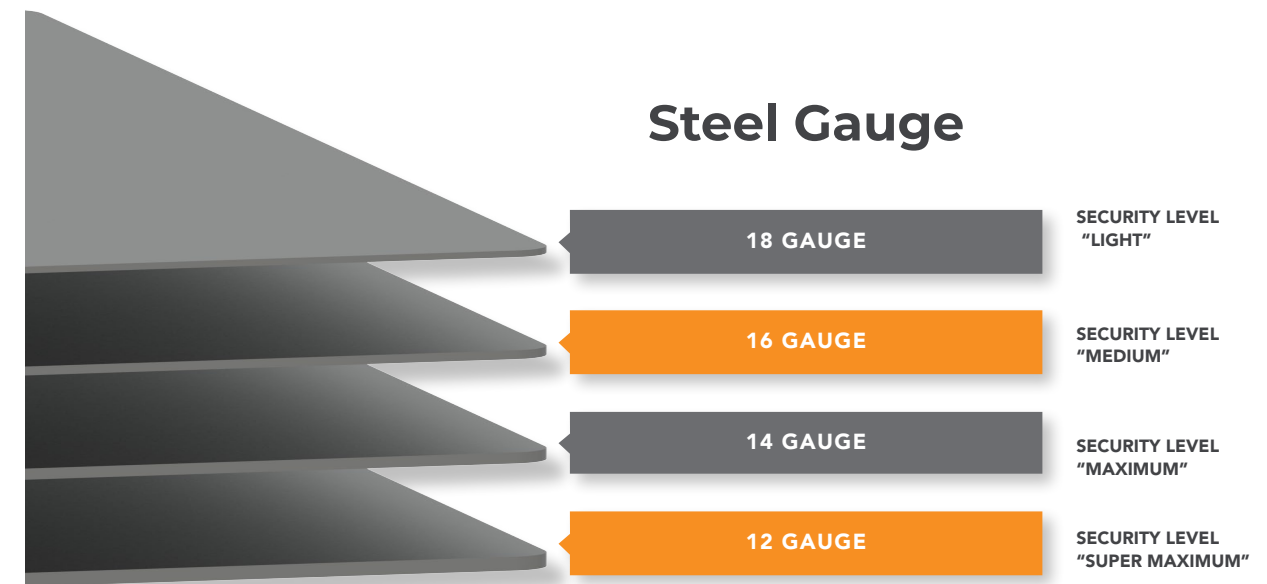



DISCOVER OUR CORRECTIONAL FIXTURES

CORNER AND WALL-MOUNT LUMINAIRES

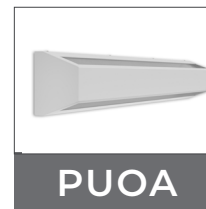

RECESSED LUMINAIRES



SURFACE MOUNT LUMINAIRES



EXTERIOR LUMINAIRE



STEP LIGHT



CORNER & WALL-MOUNT LUMINAIRES

EXPERIENCE TOP-TIER SECURITY AND DURABILITY WITH OUR CORNER MOUNT FIXTURES.

These corner-mounted fixtures feature an innovative design with a single-piece clamshell housing, advanced security lenses, and specially engineered tamper resistant fasteners.

Our commitment to excellence is evident in every detail, ensuring maximum impact resistance and thwarting any attempts at concealing contraband or unauthorized fixture tampering.



UL/CUL LISTED



IK10 RATING



IP65 LISTED

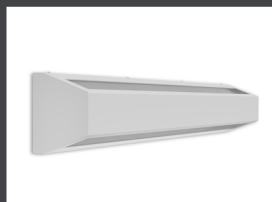

PUOA

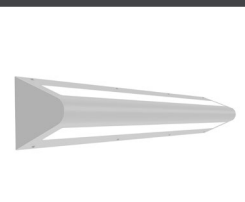

MURA



PUJA



PUMA



PUJAC



Clamshell Housing

For maximum security and vandal resistant applications.



PUJAC | Tamper Proof Corner Luminaire



Dimensions:

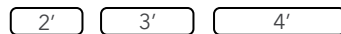

Mounting:

Corner & Wall mount

Led Options:

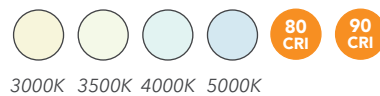

Lumen Output

Dimensions	Lumens*
2FL (24" long)	2,000
	3,000
	4,000
3FL (36" long)	2,000
	3,000
	4,000
4FL (48" long)	4,000
	5,000
	6,000

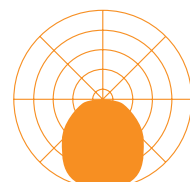

White Opal

Download
Spec Sheets & IES Files:



SAFETY & EFFICIENCY

■ Tamper proof luminaires constructed to optimize strength, durability, look and efficiency.

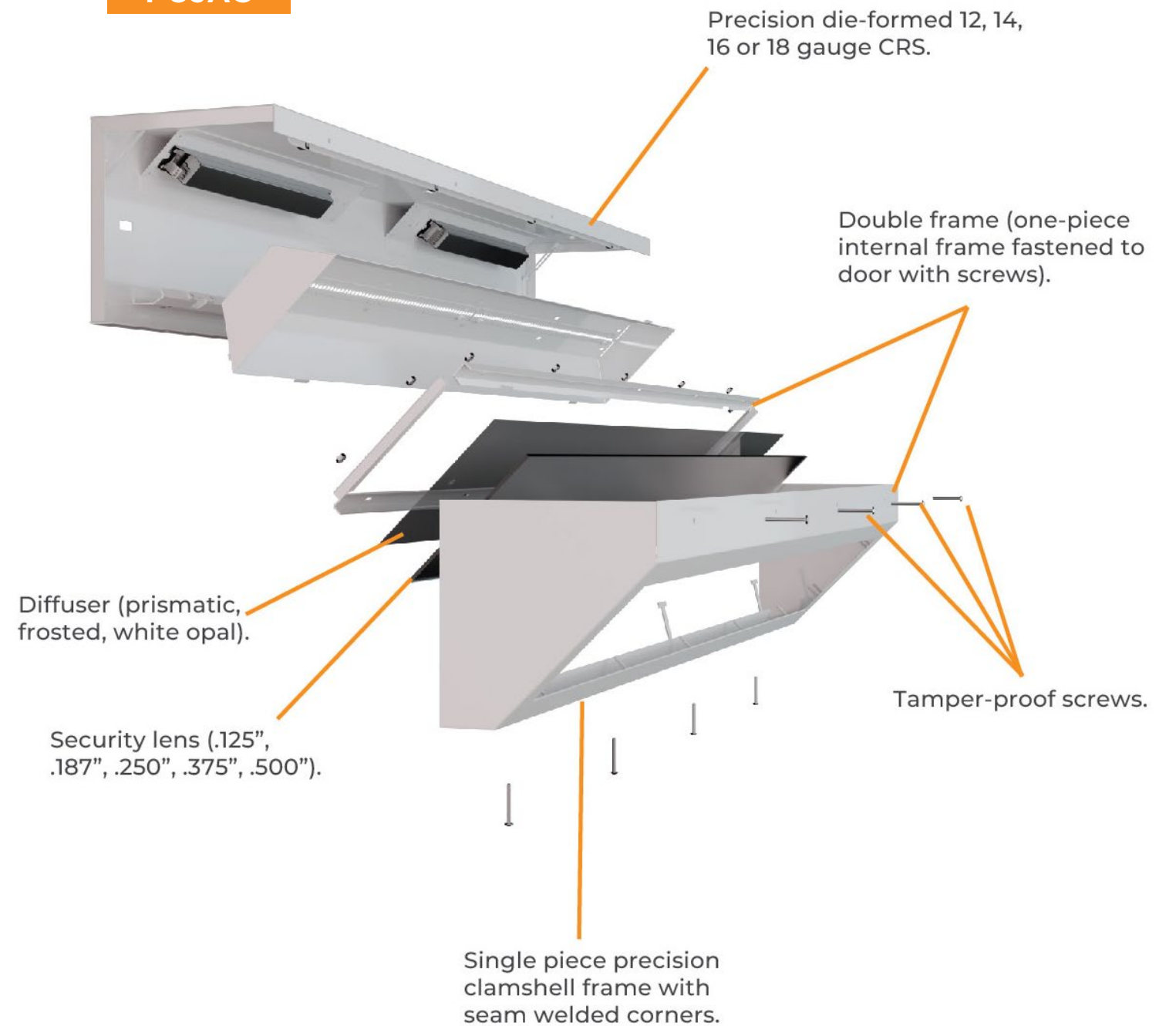

RECESSED LUMINAIRES

Our recessed luminaires are designed and engineered for maximum security prison applications.

Explore the possibilities with **ARMOR SERIES** and set new standards in lighting excellence.



PRRA | Security Recessed Luminaire



Dimensions:

10"

Mounting:

Recessed & Downlight

Led options:

3000K 3500K 4000K 5000K 80 IRC 90 IRC

Lumen Output

Lumens*

2,000

4,000

* Custom lumen package available



Download
Spec Sheets & IES Files:

PRRA

PRPA | High-Security Recessed Luminaire



Dimensions:

1'x 4' 2'x 2' 2'x 4'

Mounting:

Recessed

Led Options:

3000K 3500K 4000K 5000K TW 80 CRI 90 CRI

Lumen Output

Dimensions Lumens*

12"x48" 3000

4000

5000

24"x24" 3000

4000

5000

24"x48" 4000

6000

8000

12,000 * Custom lumen package available

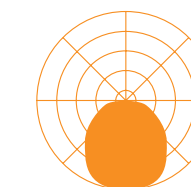

White Opal

Download
Spec Sheets & IES Files:

PRPA

PRTA | High-Security Recessed Luminaire for T-bar Ceilings



Dimensions:

1'x 4' 2'x 2' 2'x 4'

Mounting:

Recessed

Led Options:

3000K 3500K 4000K 5000K TW 80 CRI 90 CRI

Lumen Output

Dimensions Lumens*

12"x48" 3000

4000

5000

24"x24" 3000

4000

5000

24"x48" 4000

6000

8000

12,000 * Custom lumen package available

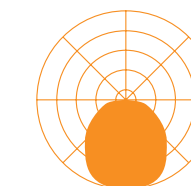

White Opal

Download
Spec Sheets & IES Files:

PRTA

Anti-Vandal

Recessed Linear Luminaire

MRGAL - 4FT



MRGAL | Linear Luminaire



Dimensions:

2' 4' 6' 8'

Mounting:

Recessed

Led Options:

3000K 3500K 4000K 5000K TW 80 CRI 90 CRI

Lumen Output

Dimensions	Lumens*
4F (45" long)	500 Lumens Per Foot
	750 Lumens Per Foot
	1000 Lumens Per Foot
	1500 Lumens Per Foot



Download
Spec Sheets & IES Files:

MRGAL ↗

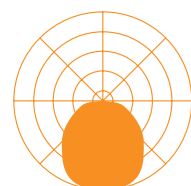

White Opal

MRGA1 | Recessed Troffer Luminaire



Download
Spec Sheets & IES Files:

MRGA1 ↗

Dimensions:

1'x 4' 2'x 2' 2'x 4'

Mounting:

Recessed

Led Options:

3000K 3500K 4000K 5000K TW 80 CRI 90 CRI

Lumen Output

Dimensions	Lumens*
12"x48"	3000
	4000
	6000
24"x24"	3000
	4000
	6000
24"x48"	4000
	6000
	8000
	10,000

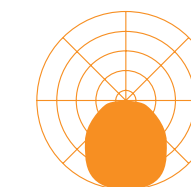

White Opal

* Custom lumen package available

MRGA2 | Recessed Troffer Luminaire



Download
Spec Sheets & IES Files:

MRGA2 ↗

Dimensions:

1'x 4' 2'x 2' 2'x 4'

Mounting:

Recessed

Led Options:

3000K 3500K 4000K 5000K TW 80 CRI 90 CRI

Lumen Output

Dimensions	Lumens*
12"x48"	3000
	4000
	6000
24"x24"	3000
	4000
	6000
24"x48"	4000
	6000
	8000
	10,000

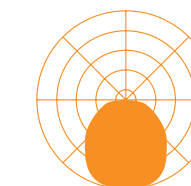

White Opal

* Custom lumen package available

MEDOLIA

Sealed Downlights

The Medolia family offers a complete solution of institutional downlights designed to meet the most stringent performance, safety, appearance, and flexibility needed for specialty applications.

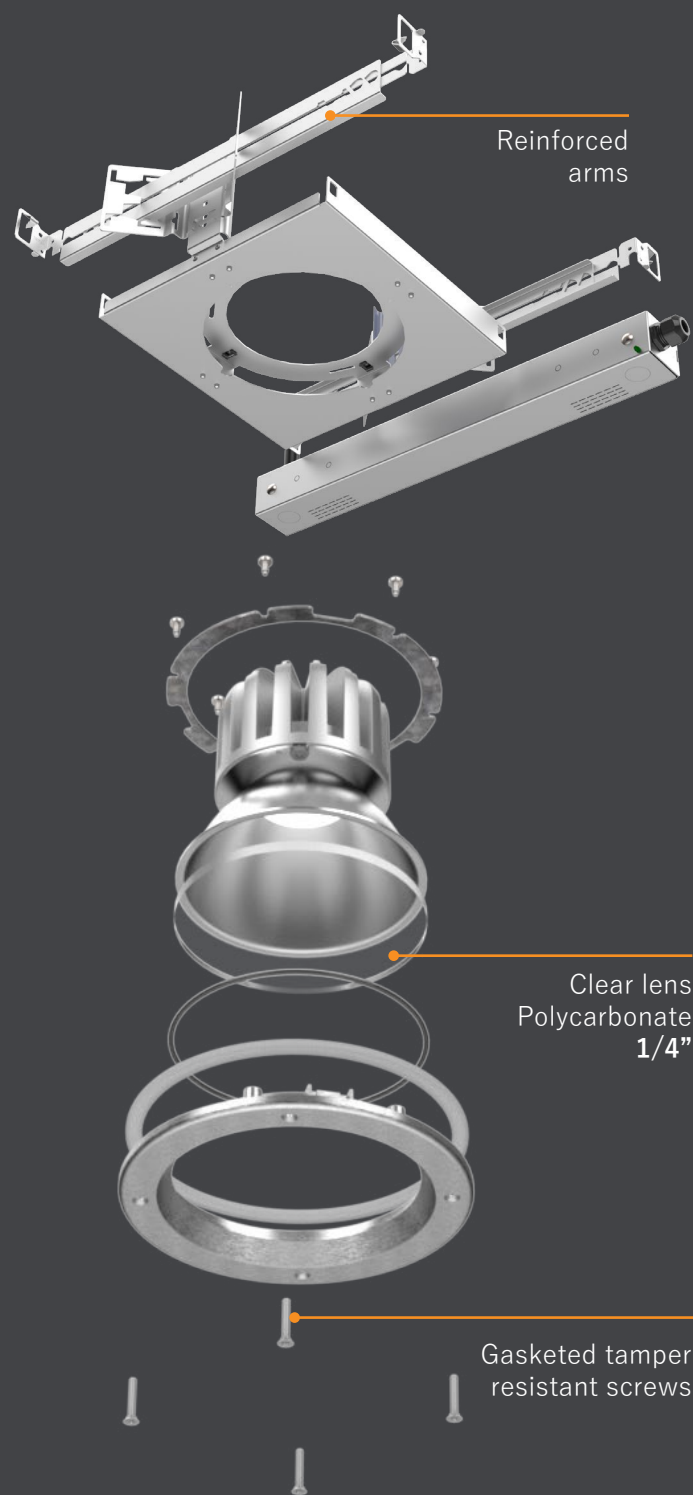

MDA4 | Vandal-Resistant Luminaire



Download
Spec Sheets & IES Files:



Dimensions: **Mounting:**

4"

Recessed

Led options:

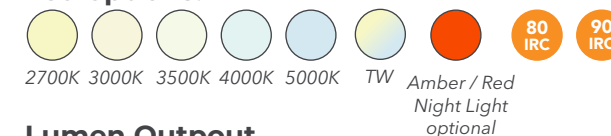

Lumen Output

Lumens*	Led options
500	White
1000	White
2000	White
3000	White
4000	White
1500 / 200	White / Red
1500 / 300	White / Amber
200	Red
300	Amber

* Custom lumen package available

MDA6 | Vandal-Resistant Luminaire



Download
Spec Sheets & IES Files:



Dimensions: **Mounting:**

6"

Recessed

Led options:

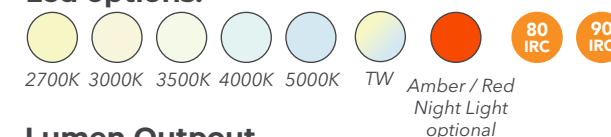

Lumen Output

Lumens*	Led options
500	White
1000	White
2000	White
3000	White
4000	White
1500 / 200	White / Red
1500 / 300	White / Amber
200	Red
300	Amber

* Custom lumen package available

SURFACE MOUNT LUMINAIRES

Experience the perfect fusion of robust security design and energy-efficient technology with our premium luminaires.

Our surface-mount luminaires are meticulously crafted to meet the stringent demands of diverse environments, including shower areas, inmate cells, psychiatric wards, secure corridors, and general population areas.



PUFA



PUCSA



PUWA



PUCSW



PUSA



WET LOCATION



UL/CUL LISTED



IK10 RATING



Haute Sécurité

Luminaire LED à Trois Fenêtres

PUFA



PUFA | Security Surface Luminaire



Dimensions:

2' 4'

Mounting:

Surface Mount

Led Options:

3000K 3500K 4000K 5000K TW 80 CRI 90 CRI

Lumen Output

Dimensions	Lumens*
2F (23" long)	3,000 4,000
4F (45" long)	4,000 6,000 8,000

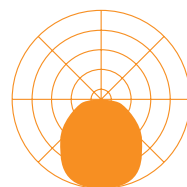

White Opal

* Custom lumen package available

Download
Spec Sheets & IES Files:

PUFA

PUWA | Tamper-Resistant Luminaire

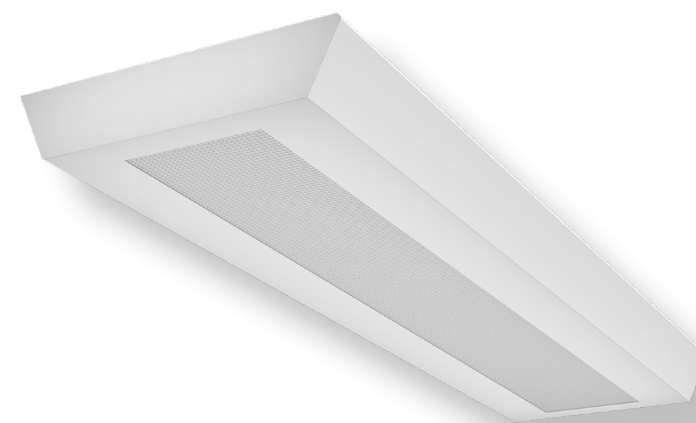

Dimensions:

2' 4'

Mounting:

Surface Mount

Led Options:

3000K 3500K 4000K 5000K TW 80 CRI 90 CRI

Lumen Output

Dimensions	Lumens*
2F (23" long)	3,000 4,000
4F (45" long)	4,000 6,000 8,000

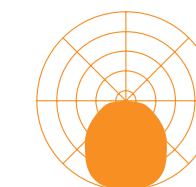

White Opal

* Custom lumen package available

Download
Spec Sheets & IES Files:

PUWA

PUSA | High security Surface Luminaire

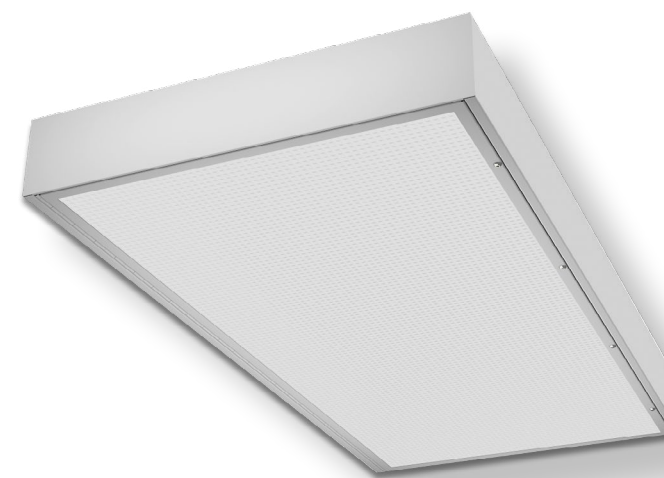

Dimensions:

12"x48" 24"x24" 24"x48"

Mounting:

Recessed

Led Options:

3000K 3500K 4000K 5000K TW 80 CRI 90 CRI

Lumen Output

Dimensions	Lumens*
12"x48"	3000 4000 5000
24"x24"	3000 4000 5000
24"x48"	4000 6000 8000

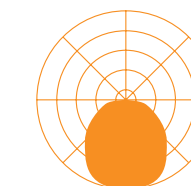

White Opal

* Custom lumen package available

Download
Spec Sheets & IES Files:

PUSA

IMPACT RESISTANT LUMINAIRES

Our Luminaires are designed for high-abuse public spaces featuring robust construction without compromising lighting performance, aesthetics, and energy efficiency.

PUCSA & PUCSW features rigid polycarbonate security lenses, tamper-resistant fasteners, and heavy-duty gauge cold rolled or galvanneal housing with die-cast aluminum caps.

Recommended use: public spaces such as parking garages, entryways, stairwells, locker rooms, corridors, and common areas



PUCSA | High-Abuse Wraparound Luminaire



Dimensions:

2' 4'

Mounting:

Surface Mount

Led Options:

3000K 3500K 4000K 5000K TW 80 CRI 90 CRI

Lumen Output

Dimensions	Lumens*
2F (24" long)	2,000 4,000
4F (45" long)	4,000 6,000 8,000

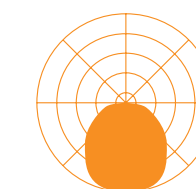

White Opal

* Custom lumen package available

Download
Spec Sheets & IES Files:



PUCSW | High-Abuse Sealed Wraparound Luminaire



Dimensions:

2' 4'

Mounting:

Surface Mount

Led Options:

3000K 3500K 4000K 5000K TW 80 CRI 90 CRI

Lumen Output

Dimensions	Lumens*
2F (24" long)	2,000 4,000
4F (45" long)	4,000 6,000 8,000

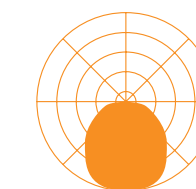

White Opal

* Custom lumen package available

Download
Spec Sheets & IES Files:





In Wall

Vandal-Resistant Luminaire

AC700



AC700 | Exterior Vandal Proof Luminaire

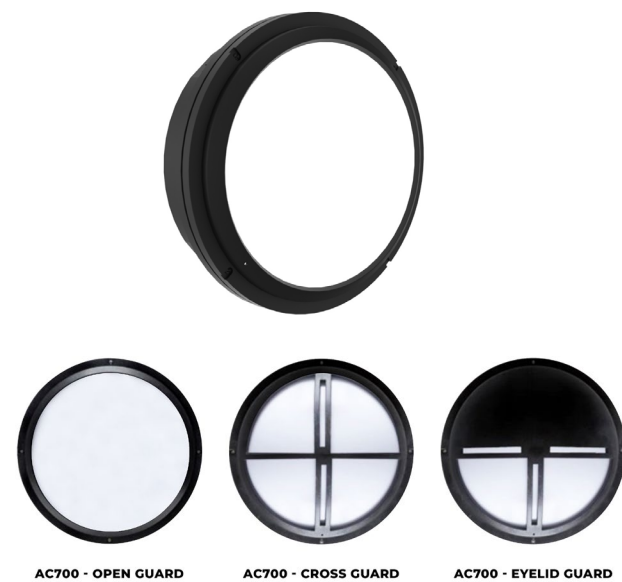

AC700 - OPEN GUARD AC700 - CROSS GUARD AC700 - EYELID GUARD



Dimensions:

13"

Mounting:

Wallmount

Led options:

3000K 3500K 4000K 5000K 80 IRC 90 IRC

Lumen Output

Lumens*
2,000
3,000
4,000
5,000

* Custom lumen package available

Download
Spec Sheets & IES Files:

AC700



Vandal-Resistant Step Light



CSLA | Correctional grade night light



Dimensions: 6x4"

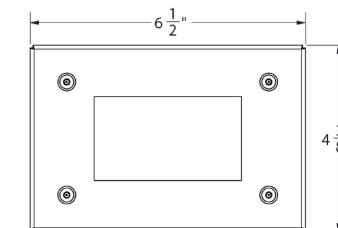

Mounting: Wallmount

Led options:

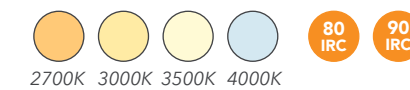

Led board options:



Lumen Output

Lumens*

- 300
- 500
- 1,000

* Custom lumen package available



Download
Spec Sheets & IES Files:



INNOVATIVE HIGH-ABUSE LUMINAIRES

Follow Us:



LinkedIn



Facebook



Instagram



780 salaberry
Laval QC H7S 1H3
450.668.9620



info@pacolighting.com
www.pacolighting.com

